



## User Manual

### MONORIM T3S PRO+



## Contents

1 Riding Safety .....	02
2 Packing List .....	04
3 Diagram .....	05
4 Assembling Your KickScooter .....	06
5 First Ride .....	07
6 Charging .....	08
7 Learning to Ride .....	08
8 Warnings .....	10
9 Folding and Carrying .....	14
10 Maintenance .....	15
11 Specifications .....	16
12 Certifications .....	17
13 Trademark and Legal Statement .....	20
14 Contact .....	21

## Thanks for choosing the Ninebot KickScooter Max!

Thanks for choosing the Ninebot KickScooter Max (hereinafter referred to as KickScooter)!

Your KickScooter is a recreational product with mobile app, allowing you to connect with other riders.

Enjoy your ride and connect with riders worldwide!



# 1 Riding Safety

1. The KickScooter is a recreational product. Before mastering riding skills, you need to practice. Neither Ninebot Inc. (means Ninebot (Beijing) Tech Co., Ltd. and its subsidiaries and affiliates) nor Segway Inc. is responsible for any injuries or damage caused by a rider's inexperience or failure to follow the instructions in this document.
2. Please understand that you can reduce the risk by following all the instructions and warnings in this manual, but you cannot eliminate all the risks. Remember that whenever you ride the KickScooter you risk injury from loss of control, collisions, and falls. When entering into public spaces always comply with the local laws and regulations. As with other vehicles, faster speeds require longer braking distance. Sudden braking on low traction surfaces could lead to wheel slip, or falls. Be cautious and always keep a safe distance between you and other people or vehicles when riding. Be alert and slow down when entering unfamiliar areas.
3. Always wear a helmet when riding. Use an approved bicycle or skateboard helmet that fits properly with the chin strap in place, and provides protection for the back of your head.
4. Do not attempt your first ride in any area where you might encounter children, pedestrians, pets, vehicles, bicycles, or other obstacles and potential hazards.
5. Respect pedestrians by always yielding the right of way. Pass on the left whenever possible. When approaching a pedestrian from the front, stay to the right and slow down. Avoid startling pedestrians. When approaching from behind, announce yourself and slow down to walking speed when passing. Please obey local traffic laws and regulations if situation is different.
6. In places without laws comply with the safety guidelines outlined in this manual. Neither Ninebot Inc. nor Segway Inc. is responsible for any property damage, personal injury/death, accidents, or legal disputes caused by violations of the safety instructions.
7. Do not allow anyone to ride your KickScooter on his/her own unless they have carefully read this manual and followed the New Rider Tutorial in the App. The safety of new riders is your responsibility. Assist new riders until they are comfortable with the basic operation of the KickScooter. Make sure each new rider wears a helmet and other protective gear.
8. Before each ride check for loose fasteners and damaged components. If the KickScooter makes abnormal sounds or signals an alarm, immediately stop riding. Diagnose your KickScooter via the Segway-Ninebot App and call your dealer/distributor for service.

9. Be alert! Scan both far ahead and in front of your KickScooter — your eyes are your best tool for safely avoiding obstacles and low traction surfaces (including, but not limited to, wet ground, loose sand, loose gravel, and ice).
10. To reduce risk of injury, you must read and follow all “CAUTION” and “WARNING” notices in this document. Do not ride at an unsafe speed. Under no circumstance should you ride on roads with motor vehicles. The manufacturer recommends riders be 14+ years old. Always follow these safety instructions:
  - A. People who should not ride the KickScooter include:
    - i. Anyone under the influence of alcohol or drugs.
    - ii. Anyone who suffers from disease that puts them at risk if they engage in strenuous physical activity.
    - iii. Anyone who has problems with balance or with motor skills that would interfere with their ability to maintain balance.
    - iv. Anyone whose weight is outside the stated limits (see Specifications).
    - v. Pregnant women.
  - B. Riders under the age of 18 years old should ride under adult supervision.
  - C. Comply with local laws and regulations when riding this product. Do not ride where prohibited by local laws.
  - D. To ride safely, you must be able to clearly see what is in front of you and you must be clearly visible to others.
  - E. Do not ride in the snow, in the rain, or on roads which are wet, muddy, icy, or that are slippery for any reason. Do not ride over obstacles (sand, loose gravel, or sticks). Doing so could result in a loss of balance or traction and could cause a fall.
11. Do not attempt to charge your KickScooter if, the charger, or the power outlet is wet.
12. As with any electronic device, use a surge protector when charging to help protect your KickScooter from damage due to power surges and voltage spikes. Only use the Segway supplied charger. Do not use a charger from any other different product models.
13. Use only Ninebot or Segway approved parts and accessories. Do not modify your KickScooter. Modifications to your KickScooter could interfere with the operation of the KickScooter, could result in serious injury and/or damage, and could void the Limited Warranty.

## 2 Packing List

### Assembled KickScooter



### User Materials



### Accessories

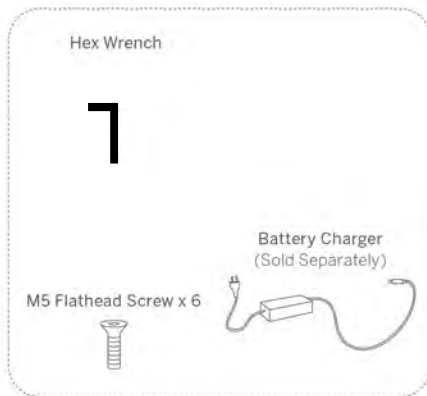

When unpacking your KickScooter, please verify that the above items are included in the package. If you are missing any components, please contact your dealer/distributor or nearest service center (see Contact in the user manual). After verifying that all components are present and in good condition, you can assemble your new KickScooter.

Please retain the box and packaging materials in case you need to ship your KickScooter in the future.

Remember to power off your KickScooter and unplug the power cord before assembling, mounting accessories, or cleaning the mainframe.

## 3 Diagram



### Dashboard & Power Button

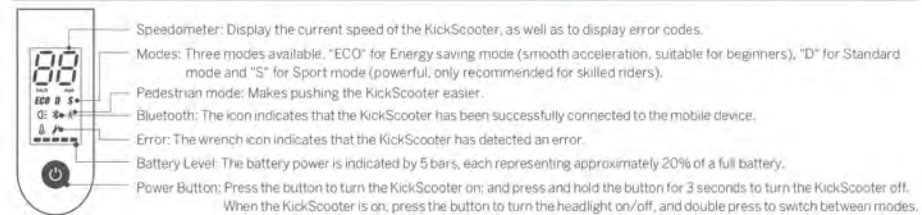



## 4 Assembling Your KickScooter

1. Unfold the handlebar stem and fasten it. Then unfold the kickstand to support the KickScooter.

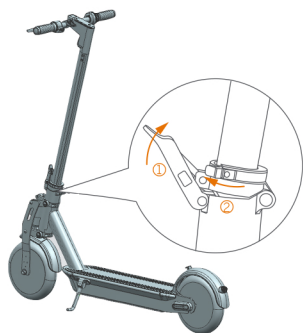

3. Install six screws (two on each side) with the included hex wrench.

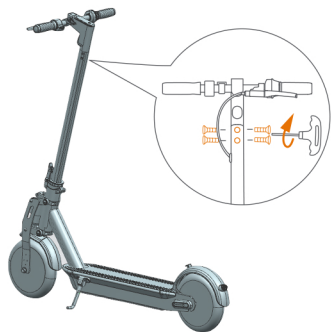

2. Firmly connect the wires inside the handle and the stem. Slide the handle onto the stem. Be aware of the correct orientation.

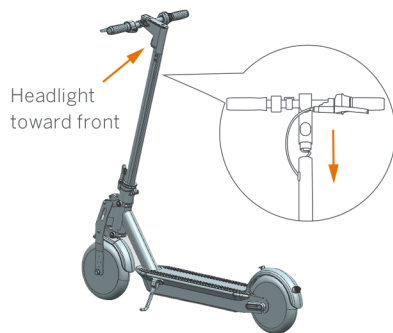

4. Verify that your KickScooter can be powered on and off.



## 5 First Ride

▲ There are safety risks when learning to ride the KickScooter. You must read the Riding Safety via the App before your first ride.



For your safety, your new KickScooter is not activated and will beep occasionally after Power ON.

Until activated, the KickScooter maintains very low riding speed, and cannot be ridden with full function. Install the App on your mobile device (with Bluetooth 4.0 or above), connect to the KickScooter with Bluetooth, and follow the App instructions to activate your KickScooter and enjoy the full performance.

Scan the QR code to download the App.

1. Install the App and register/login.

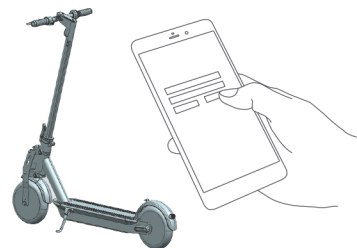

2. Power on the KickScooter. A blinking Bluetooth icon indicates the KickScooter is waiting for a connection.



3. Click "Vehicle" → "Scan for Vehicle" to connect to your KickScooter. The KickScooter will beep when the connection is successful. The Bluetooth icon will stop blinking and remain illuminated.

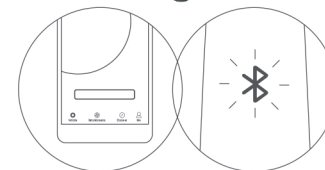

4. Follow the App instructions to activate the KickScooter and learn how to ride safely. You can now start to use your KickScooter, check the status with App, and interact with other users. Have fun!

## 9 Model parameter table

Performance index	Item	Electric scooter parameters
Product dimension	Length × width × height [1] (cm)	123*23*63cm
	After folding: Length × width × height (cm)	53*49.3*63
Product weight	Weight of finished automobile	About 2 5 . 1 k g
Riding request	Maximum load (kg)	100
	Applicable age (years)	16-50
	Applicable height (cm)	120-200
The main parameters of the vehicle	Maximum speed (km/h)	About 2 5 - 2 8
	Typical life [2] (km)	About 30
	Maximum gradient ( % )	About 14
	Applicable terrain	Cement, asphalt pavement, flat soil pavement, no more than 1cm steps, no more than 3cm wide channel
	Working temperature °C	-10-40
	Storage temperature (°C)	-20-45
	Protection grade	IP54
Battery pack parameters	Rating voltage (VDC)	4 8 V =
	Maximum charge voltage (VDC)	5 4 . 6 V =
	Rated capacity (Wh)	500w
	Intelligent battery management system	Temperature abnormality / short circuit / undervoltage to auto sleep / overflow current / double overcharge / double over discharge protection
Motor parameters	Rated power (W)	480w
	Maximum power (W)	500w
Charger parameters	Rated power (W)	71
	Rated input voltage (VAC)	100-240V~
	Rated output voltage (VDC)	5 4 . 6 V =
	Rated current (A)	2ah
	Product certification	C E , F C C , RoHS
	Charging time (h)	about 5

(1) Body height: The distance from the ground to the top of its body

(2) Typical life: When the electric scooter is full, 75kg load, 25 degrees Celsius, flat road without wind environment, in the energy-saving mode to keep at 15km / h even speed conditions measured, the actual life due to load, temperature, wind speed, road and operating habits and other factors to be different.

Note: Data and parameters vary with different models. Subject to change without notice.

## 3 Body assembly



## 6 Charging



### Charging step tips



Open the charge port cover.



Insert the charge plug.



Close the charge port cover when finished.

### ▲ WARNING

Do not charge if the charge port or power cord is wet.

Do not charge or use your battery if it is damaged or see trace of water.

Close the charge port cover when not charging.

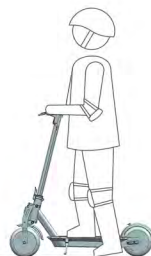

2. Stand on the footrest with one foot and push off with another foot to start gliding.

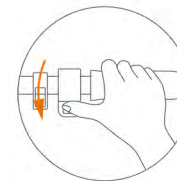

3. Put your other foot on the footrest to keep both feet stable. Press the throttle on the right hand to speed up when you are balanced.

Note, for your safety, the motor will not engage until the KickScooter reaches 1.86 mph (3 km/h).

## 7 Learning to Ride



Wear an approved helmet and other protective gear to minimize any possible injury.



1. Power on the KickScooter and check the power level indicator. Charge the KickScooter if the battery level is low.

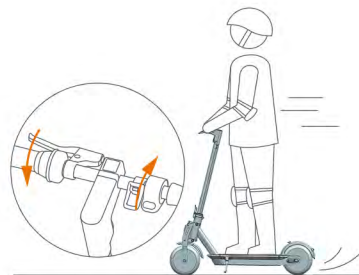

4. Slow down by releasing the throttle; and brake by squeezing the brake lever.

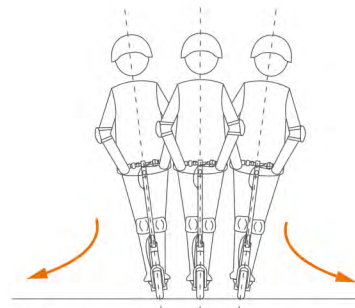

5. To turn, shift your body weight and turn the handle slightly.

### ▲ WARNING

When hard braking, you risk serious injury due to loss of traction and falls. Maintain a moderate speed and look out for potential hazards.

## 8 Warnings

**⚠ WARNING**  
Failure to follow these instructions could lead to serious injury.



**⚠** DO NOT ride the KickScooter in the rain. DO NOT get wet.



**⚠** DO NOT ride over speed bumps, thresholds, or other bumps at HIGH SPEED.

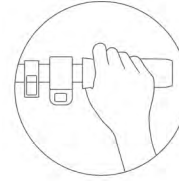

**⚠** DO NOT press the throttle when walking with the KickScooter.



**⚠** Avoid contacting obstacles with the tire/wheel.

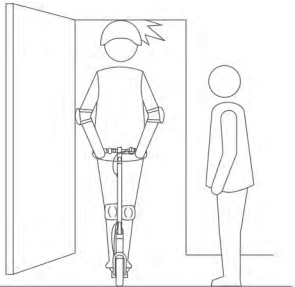

**⚠** Watch your head when passing through doorways.



**⚠** Do not keep your feet on the rear fender.

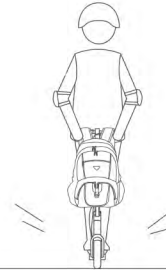

**⚠** DO NOT carry heavy objects on the handlebar.



**⚠** DO NOT ride the KickScooter with only one foot.

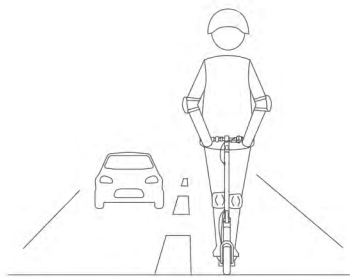

**⚠** DO NOT ride on public roads, motorways, or highways.

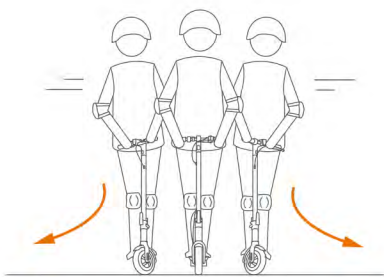

**⚠** DO NOT rotate the handle violently while driving at high speed.

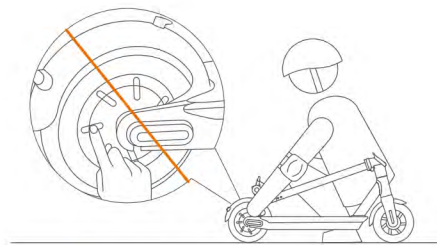

**⚠** DO NOT touch the hub motor after riding because it can get hot.



**⚠** DO NOT take your hands off the handlebar while riding. Do not ride with one hand only.



**⚠** DO NOT ride through puddles or other bodies of water.

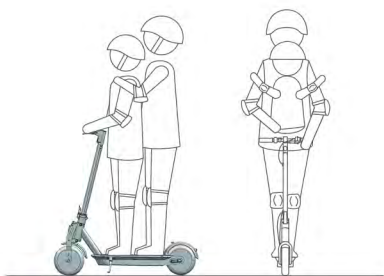

**⚠** The KickScooter is for one rider only. Do not carry any passengers. Do not carry a child. Do not ride when pregnant.

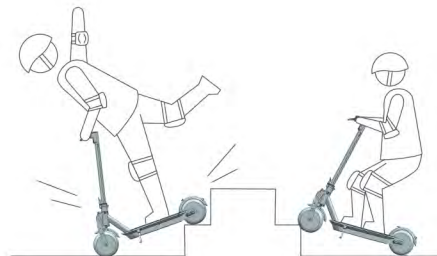

**⚠** DO NOT ride up and down stairs or jump over obstacles.



**⚠** Do not use mobile phone or wear earphones when operating the KickScooter.

**⚠ WARNING**  
Always keep both hands on the handlebar or you risk serious injury due to loss of balance and falls.



## 9 Folding and Carrying

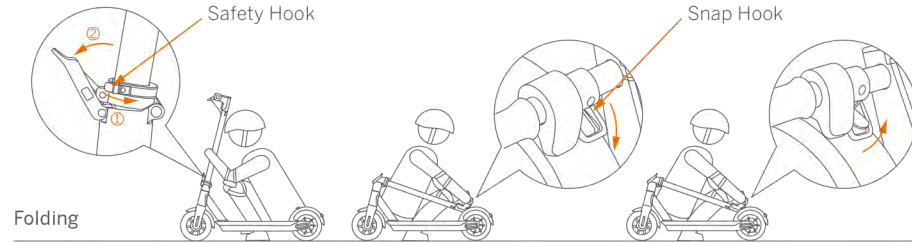

### Folding

Turn off your KickScooter. Turn the safety hook counterclockwise and open the quick release lever.

Align the snap hook and the buckle and hook them.

Disengage the snap hook from the buckle. Fold the handlebar stem up, close the quick release lever and turn the safety hook clockwise.

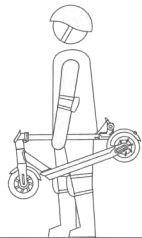

### Carrying

When your KickScooter is folded up, lift it by the stem to carry.

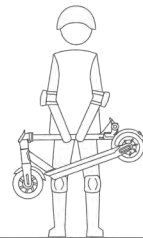

## 10 Maintenance

### Cleaning and Storage

Use a soft, wet cloth to wipe the mainframe clean. Dirt hard to remove can be scrubbed with a toothbrush and toothpaste, then cleaned with a soft, wet cloth.

### NOTE

Do not wash your KickScooter with alcohol, gasoline, acetone, or other corrosive/volatile solvents. These substances may damage the appearance and internal structure of your KickScooter. Do not wash your KickScooter with a power washer or hose.

### ⚠ WARNING

Make sure the KickScooter is powered OFF, the power cord is unplugged, and the rubber cap on the charge port is tightly sealed before cleaning; otherwise you may damage the electronic components.

Store your KickScooter in a cool, dry place. Do not store it outdoors for extended periods of time. Exposure to sunlight and temperature extremes (both hot and cold) will accelerate the aging process of the plastic components and may reduce battery life.

### Tire Pressure

Inflate tires to 32–37 psi. Inflate both tires equally.

### Battery Pack Maintenance

Do not store or charge the battery at temperatures outside the stated limits (see Specifications). Do not puncture the battery. Refer to your local laws and regulations regarding battery recycling and/or disposal.

A well maintained battery can perform well even after many miles of riding. Charge the battery after each ride and avoid draining the battery completely. When used at room temperature (70°F [22°C]) the battery range and performance is at its best; whereas using it at temperatures below 32°F (0°C) can decrease range and performance. Typically, at -4°F (-20°C) range can be half that of the same battery at 70°F (22°C). Battery range will recover when temperature rises. More details are available in the App.

### NOTE

Typically, a fully charged battery should retain power for 120-180 days. A low-power battery should retain power for 30–60 days. Remember to charge the battery after each use. Completely draining the battery may cause permanent damage to the battery. Electronics inside the battery record the charge-discharge condition of the battery; damage caused by over-charging or under-charging will not be covered by the Limited Warranty.

### ⚠ WARNING

Do not attempt to disassemble the battery. Do not touch battery contacts. Do not dismantle or puncture the casing. Keep the battery contacts away from metal objects to prevent short circuit. Risk of fire and electric shock. No user serviceable parts. Do not charge or use your battery if it is damaged or see trace of water.

### ⚠ WARNING

Do not ride when the ambient temperature is outside the machine operation temperature (see Specifications) because low/high temperature will limit the maximum power/torque. Doing so could cause personal injury or property damage due to slips or falls.